

AMT1305M
7 - 13GHz Multi-Function Chip

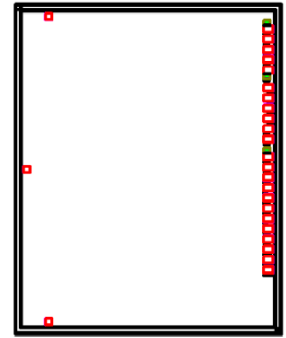

Key Features :

- Frequency range : 7 – 13GHz
- Receiver gain : 6dB
- Transmitter gain : 6dB
- Receiving, Transmitting P-1 : 11/11dBm
- Phase shift bit : 6 bits
- Phase shift step : 5.625°
- Phase shift RMS : 4.8°, Phase shift additive attenuation ±1.5dB
- Attenuation bit : 6 bits
- Attenuation step : 0.5dB
- Attenuation RMS : 0.7dB, Attenuation additive phase shift ±15°
- Input/Output Standing Wave : 1.8
- Operating voltage : VD1/VD2/VD3/VDN : 4.3V
- Operating voltage : VSN/VSS : -2.9V
- Control method : TTL
- Chip dimensions : 3.8mm x 4.7mm x 0.1mm
- Applications : wireless communication, transceiver module, radio telecommunication etc.

Description :

AMT1305M is a multi-function chip incorporating with amplifier, switch, 6-digit attenuator, 6-digit phase shifter, control driver etc. X band MMIC, it uses Gallium Arsenide (GaAs) pHEMT process. The chip is dual voltage operation, control level is TTL, with serial control for phase shift and attenuation. This chip is designed with ground through metal vias on the back technology. All chip products p are 100% RF tested.

Absolute Maximum Ratings (Ta = 25°C)

Symbol	Parameter	Value	Remark
V _{CLK} /V _{CLR} /V _{CS} /V _{LE} /V _{T/R} /V _{DIN}	Control voltage	+6V	
VD1/VD2/VD3/VDN	Operating voltage	+7V	
VSN/VSS	Operating voltage	-6V	
Pin	Input Power	+20dBm	
Tch	Operating Temperature	150°C	
Tm	Sintering Temperature	310°C	30s, N ₂ protection
Tstg	Storage Temperature	-65 ~ +150°C	

[1] Operation outside any of the Absolute Maximum Ratings may cause permanent device damage.

Electrical Characteristics (Ta = 25°C)

Symbol	Parameter	Value			Unit	Remark
		Min	Typical	Max		
F	Frequency	7 ~ 13			GHz	
Gain	Receiver gain	5.5	6	-	dB	About 1.5dB positive slope
P-1	Receiver output at P-1 point	10.5	11	-	dBm	
NF	Noise figure	-	17	18	dB	
Gain	Transmitter gain	5.5	6	-	dB	
P-1	Transmitter output at P-1 point	11	11	-	dBm	
PS	Phase shift range	5.625 – 354.375 (6 bits phase shift)			°	
Δps	Phase shift additive attenuation variation	-1.5	-	+1.5	dB	
RMSps	Phase shift RMS	-	4.8	-	°	
ATT	Attenuation range	0.5 – 31.5 (6 bits attenuation)			dB	
Δat	Attenuation additive phase shift variation	-15	-	+15	°	
RMS _{AT}	Attenuation RMS	-	0.7	-	dB	
VSWR	Input Output Standing Wave	-	1.8	2.0		
I _d	Operation current I _d	-	85	95	mA	
I _s	Operation current I _s	-	23	25	mA	
I _{dn}	Operating current I _{dn}	-	2	4	mA	

Typical Performance

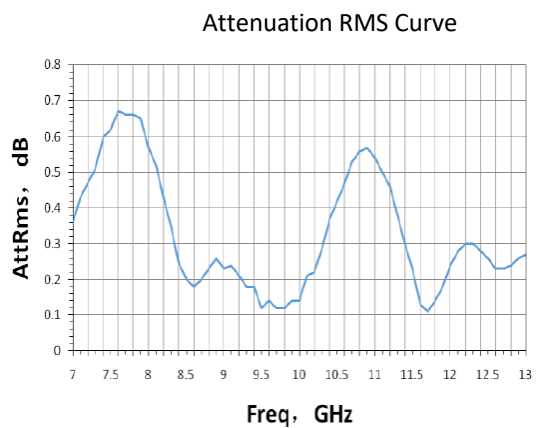
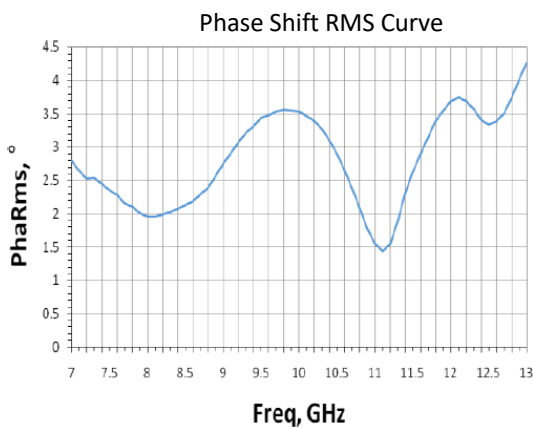
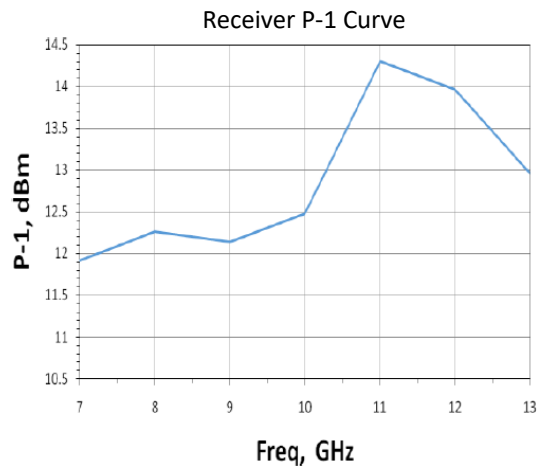
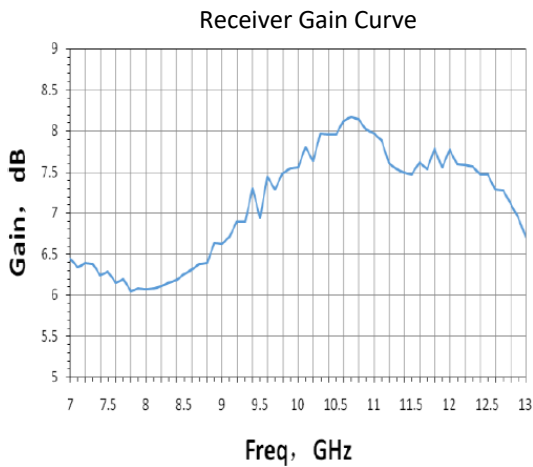

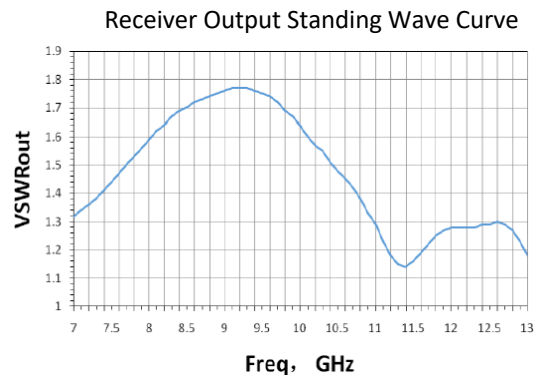
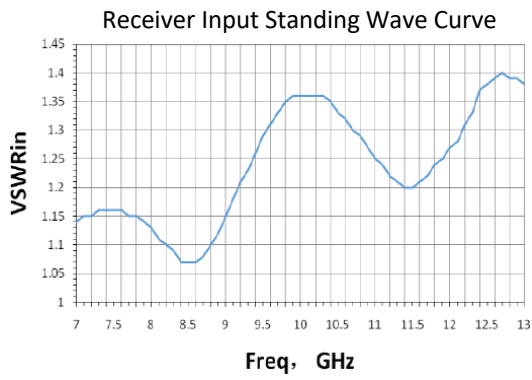

Internal Functional Block Diagram

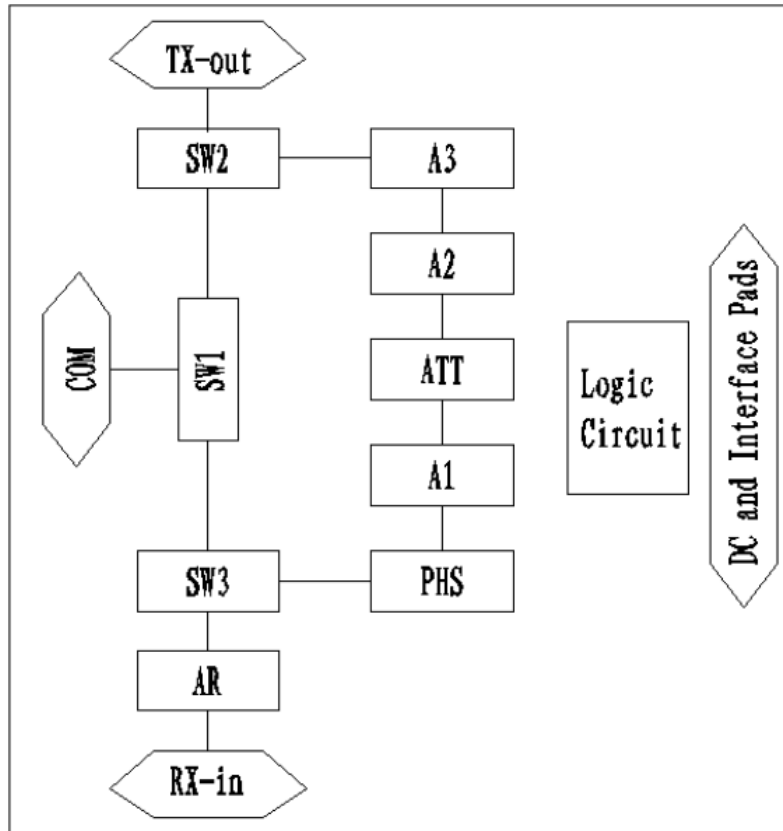

Chip Dimensions (Unit : μm)

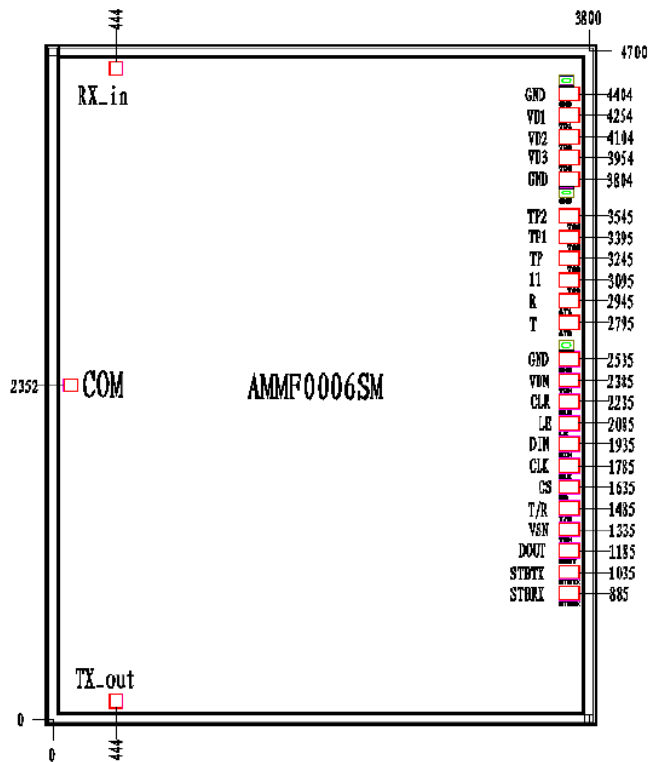
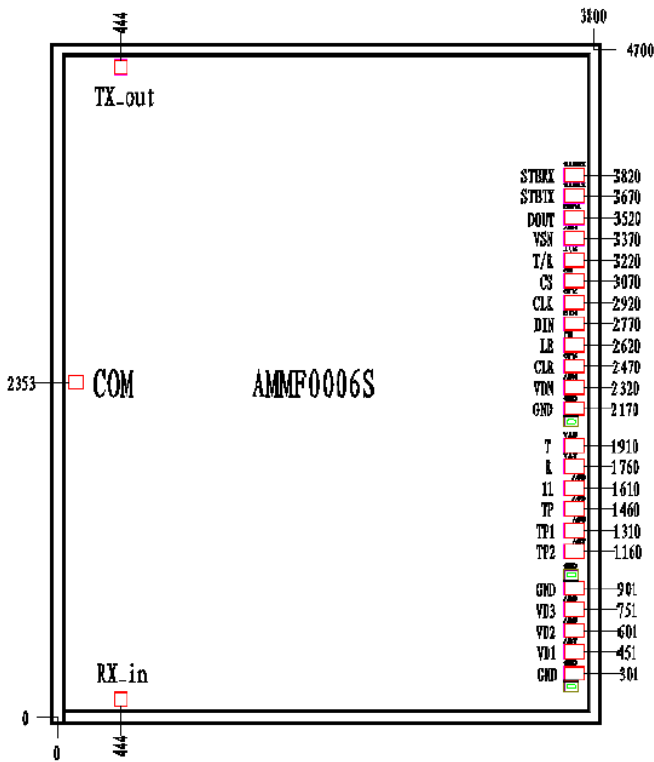

Chip Layout Diagram

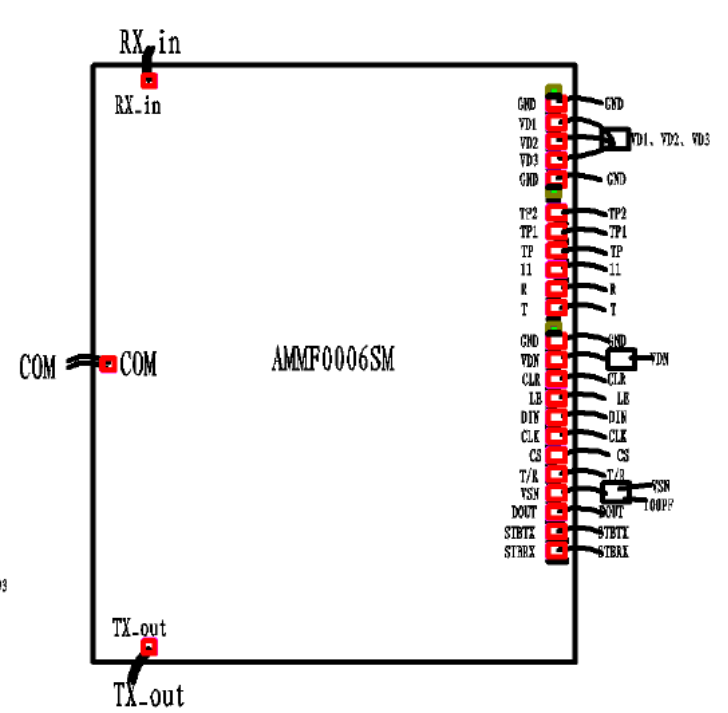
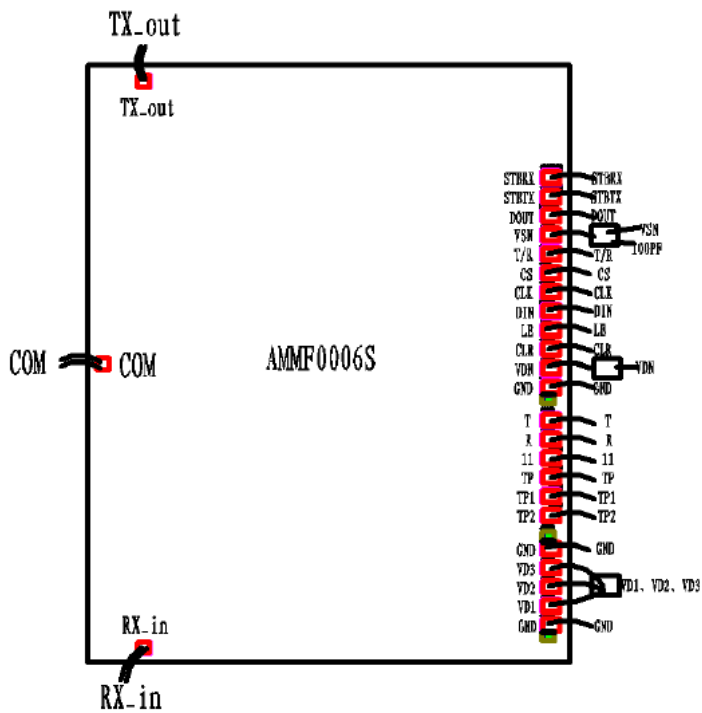

Solder Pad Definition

Name	Dimension	Remark
RX_IN/TX_OUT	100μm x 95μm	Receiver Input/Transmitter Output
COM	100μm x 95μm	Receiver Output/Transmitter Input
STBRX/STBTX/DOUT	100μm x 140μm	TTL, Output : Receive Standby/Transmit Standby/Serial Control Word
VSN/VDN/VD1,2,3	100μm x 140μm	Supply Pad : -2.9V/+4.3V/+4.3V
CS/CLK/DIN/LE/TR	100μm x 140μm	TTL, Control Signal Input, speed 40M
CLR	100μm x 140μm	TTL, Reset Signal Input
GND	100μm x 140μm	Grand Pad
TP/TP1/TP2	100μm x 140μm	TTL, Pules Control Signal Input
T/R	100μm x 140μm	TTL, Transceiver Pules Control Signal Output
11	100μm x 140μm	TTL, 11 Standby Signal Output

Control Descriptions

Signal Function Definition

No.	Singal	Level	Function		Remark	
			"0"	"1"		
1	TR	Input (TTL level)	Receive	Transmit	Transmit, receive control signal	
2	CS	Input (TTL level)	Add data	Keep data	Chip select signal, low active	
3	CLK	Input (TTL level)	-	-	Clock signal, falling edge active	
4	LE	Input (TTL level)	-	-	Data ready signal, rise edge active	
5	DI	Bit 0, Bit 1	Input (TTL level)	-	11 power down signal	
		Bit 2	Input (TTL level)	Operate	Standby	Receive standby signal : operate means normal receive status
		Bit 3 ~ Bit 26	Input (TTL level)	Off	On	Phase shift attenuation control signal : On means Shifter and Attenuator activate control
		Bit 27	Input (TTL level)	Operate	Standby	Transmit standby signal : operate means normal transmit status
6	CLR	Input (TTL level)	-	-	Reset signal : power up 100ms low level, reset starts.	
7	STBRX	Output (TTL level)	-	-	Receive standby signal	
8	STBRX	Output (TTL level)	-	-	Transmit standby signal	
9	DOUT	Output (TTL level)	-	-	Output DIN control signal : when new serial control word is sent into phase shift register, original control word stored in the register will output from DOUT port.	

Control Circuit Block Diagram

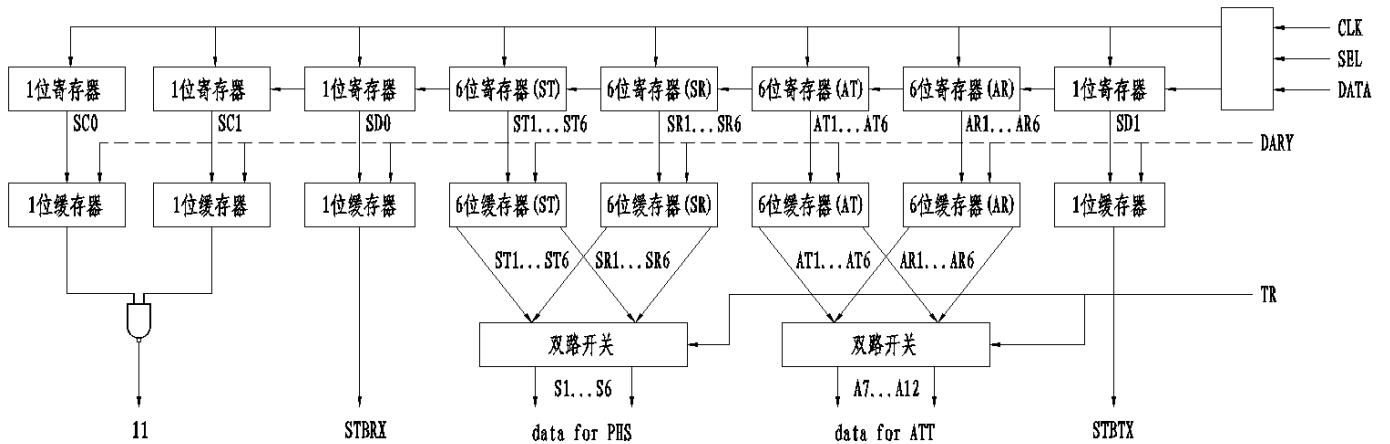

Serial Data Definition

BIT	Description	
BIT0	11 power down	
BIT1	11 power down	
BIT2	Receive standby	STBRX output
BIT3	5.625°	Transmit phase shift
BIT4	11.25°	
BIT5	22.5°	
BIT6	45°	
BIT7	90°	
BIT8	180°	
BIT9	5.625°	Receive phase shift
BIT10	11.25°	
BIT11	22.5°	
BIT12	45°	
BIT13	90°	
BIT14	180°	
BIT15	0.5dB	Transmit attenuation
BIT16	1dB	
BIT17	2dB	
BIT18	4dB	
BIT19	8dB	
BIT20	16dB	
BIT21	0.5dB	Receive attenuation
BIT22	1dB	
BIT23	2dB	
BIT24	4dB	
BIT25	8dB	
BIT26	16dB	
BIT27	Transmit standby	STBTX output

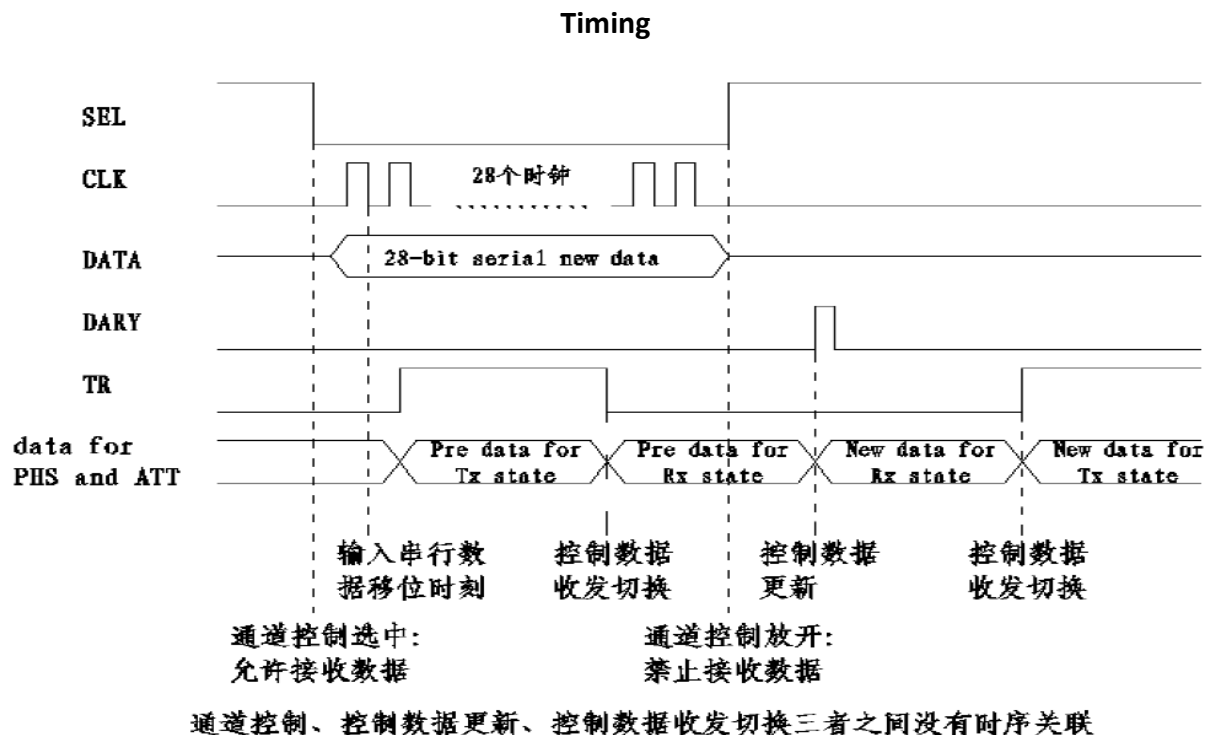

Please see Appendix A for details.